

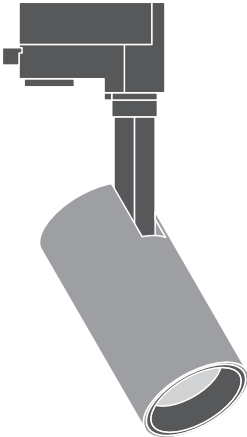
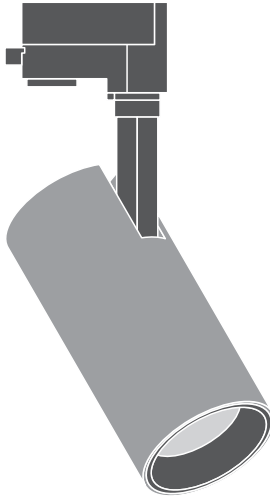
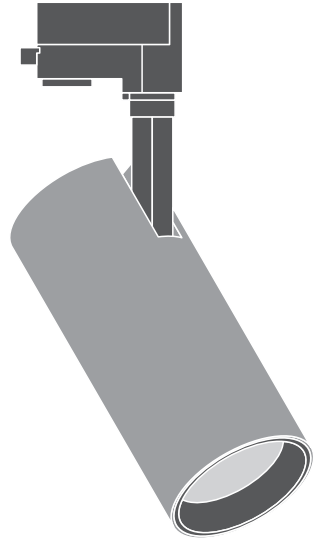

TRACKLIGHT SPOT

TRACKLIGHT SPOT D75

TRACKLIGHT SPOT D85

TRACKLIGHT SPOT D95

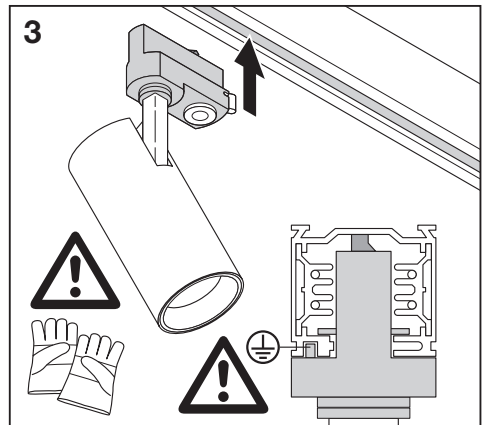
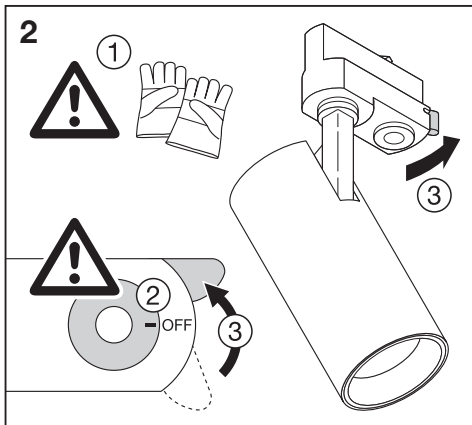
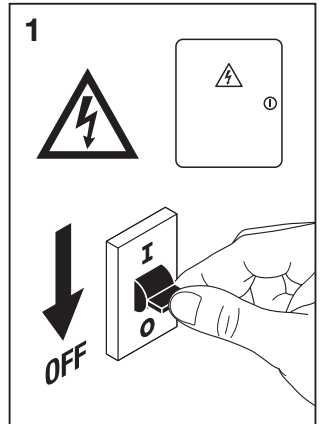
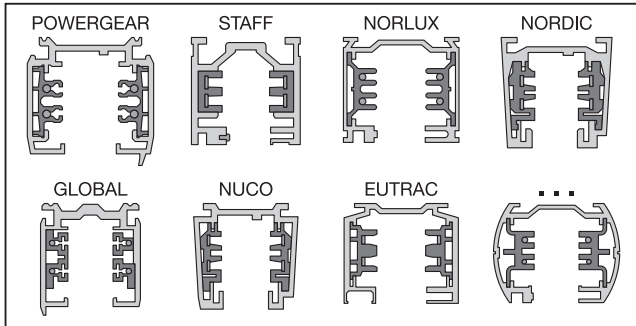
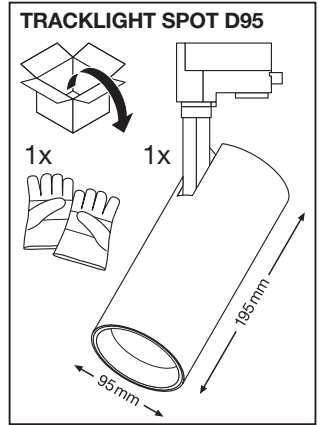
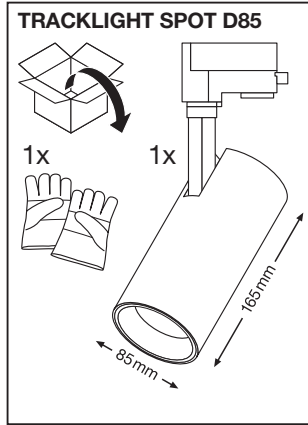
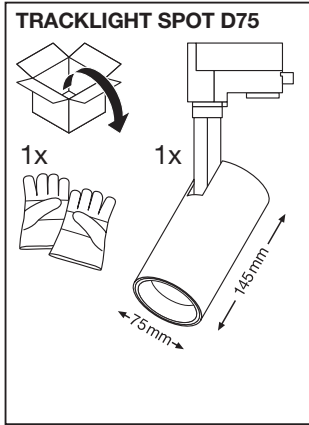
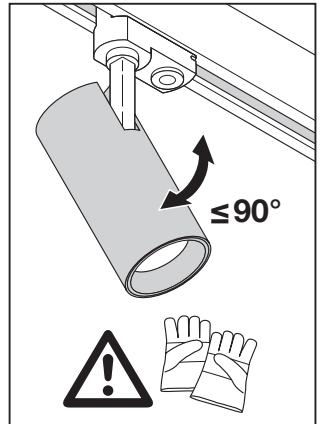
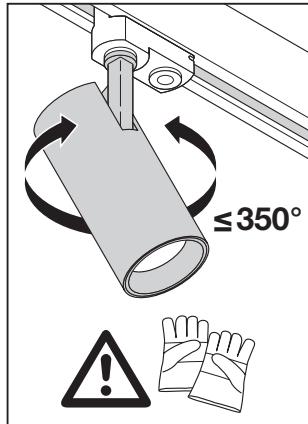
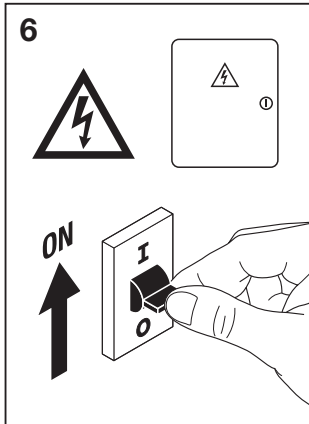
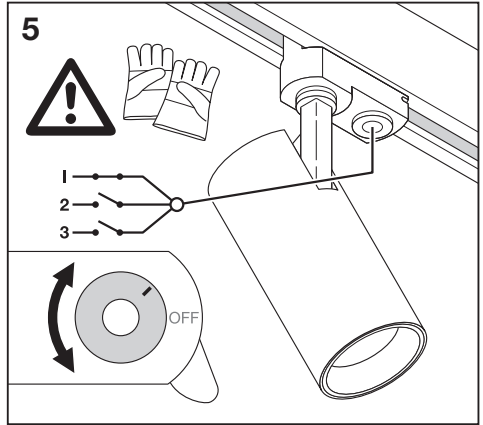
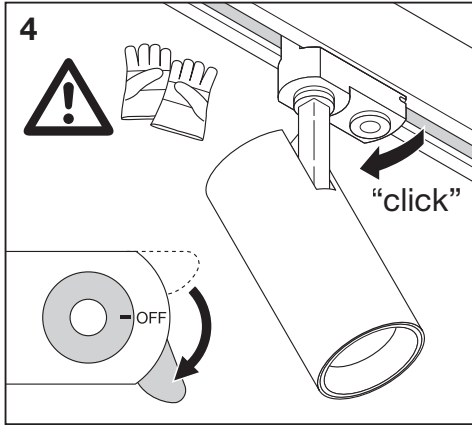
	EAN	Ø x h [mm]	W	V _{AC}	Hz	lm	lm/W	K	IP	IK	∠	R _a	°(°C)	PF	
TRACK SP D75 25W/3000K 90RA NFL WT	4058075113442	75 x 255	25	220-240V	50/60Hz	1750	70	3000	20	02	24°	>90	-20...+40	≥ 0.9	0.8 kg
TRACK SP D75 25W/4000K 90RA NFL WT	4058075113466	75 x 255	25	220-240V	50/60Hz	1900	75	4000	20	02	24°	>90	-20...+40	≥ 0.9	0.8 kg
TRACK SP D85 35W/3000K 90RA NFL WT	4058075113480	85 x 269	35	220-240V	50/60Hz	2660	70	3000	20	02	24°	>90	-20...+40	≥ 0.9	1.0 kg
TRACK SP D85 35W/4000K 90RA NFL WT	4058075113503	85 x 269	35	220-240V	50/60Hz	2800	75	4000	20	02	24°	>90	-20...+40	≥ 0.9	1.0 kg
TRACK SP D95 55W/3000K 90RA NFL WT	4058075113527	95 x 297	55	220-240V	50/60Hz	4000	70	3000	20	02	24°	>90	-20...+40	≥ 0.9	1.5 kg
TRACK SP D95 55W/4000K 90RA NFL WT	4058075113541	95 x 297	55	220-240V	50/60Hz	4200	75	4000	20	02	24°	>90	-20...+40	≥ 0.9	1.5 kg
TRACK SP D75 25W/3000K 90RA NFL BK	4058075113565	75 x 255	25	220-240V	50/60Hz	1750	70	3000	20	02	24°	>90	-20...+40	≥ 0.9	0.8 kg
TRACK SP D75 25W/4000K 90RA NFL BK	4058075113589	75 x 255	25	220-240V	50/60Hz	1900	75	4000	20	02	24°	>90	-20...+40	≥ 0.9	0.8 kg
TRACK SP D85 35W/3000K 90RA NFL BK	4058075113602	85 x 269	35	220-240V	50/60Hz	2660	70	3000	20	02	24°	>90	-20...+40	≥ 0.9	1.0 kg
TRACK SP D85 35W/4000K 90RA NFL BK	4058075113626	85 x 269	35	220-240V	50/60Hz	2800	75	4000	20	02	24°	>90	-20...+40	≥ 0.9	1.0 kg
TRACK SP D95 55W/3000K 90RA NFL BK	4058075113640	95 x 297	55	220-240V	50/60Hz	4000	70	3000	20	02	24°	>90	-20...+40	≥ 0.9	1.5 kg
TRACK SP D95 55W/4000K 90RA NFL BK	4058075113664	95 x 297	55	220-240V	50/60Hz	4200	75	4000	20	02	24°	>90	-20...+40	≥ 0.9	1.5 kg
TRACK SP D75 25W/3000K 90RA NFL GY	4058075113688	75 x 255	25	220-240V	50/60Hz	1750	70	3000	20	02	24°	>90	-20...+40	≥ 0.9	0.8 kg
TRACK SP D75 25W/4000K 90RA NFL GY	4058075113701	75 x 255	25	220-240V	50/60Hz	1900	75	4000	20	02	24°	>90	-20...+40	≥ 0.9	0.8 kg
TRACK SP D85 35W/3000K 90RA NFL GY	4058075113725	85 x 269	35	220-240V	50/60Hz	2660	70	3000	20	02	24°	>90	-20...+40	≥ 0.9	1.0 kg
TRACK SP D85 35W/4000K 90RA NFL GY	4058075113749	85 x 269	35	220-240V	50/60Hz	2800	75	4000	20	02	24°	>90	-20...+40	≥ 0.9	1.0 kg
TRACK SP D95 55W/3000K 90RA NFL GY	4058075113773	95 x 297	55	220-240V	50/60Hz	4000	70	3000	20	02	24°	>90	-20...+40	≥ 0.9	1.5 kg
TRACK SP D95 55W/4000K 90RA NFL GY	4058075113787	95 x 297	55	220-240V	50/60Hz	4200	75	4000	20	02	24°	>90	-20...+40	≥ 0.9	1.5 kg





TRACKLIGHT SPOT REFLECTOR

TRACKLIGHT SPOT D75	EAN	Ø x h [mm]	▽
TR SP REFLECTOR D75 SP	4058075113800	63x53	15°
TR SP REFLECTOR D75 FL	4058075113824	63x53	38°

TRACKLIGHT SPOT D85	EAN	Ø x h [mm]	▽
TR SP REFLECTOR D85 SP	4058075113848	75x63	15°
TR SP REFLECTOR D85 FL	4058075113862	75x63	38°

TRACKLIGHT SPOT D95	EAN	Ø x h [mm]	▽
TR SP REFLECTOR D95 SP	4058075113886	82x69	15°
TR SP REFLECTOR D95 FL	4058075113909	82x69	38°

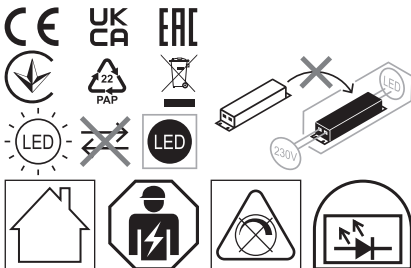
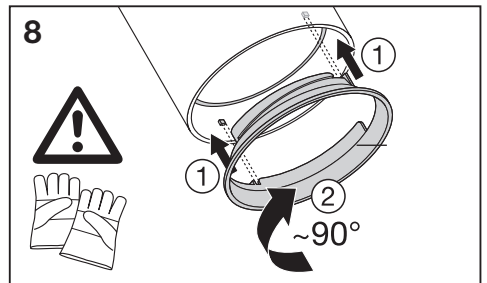
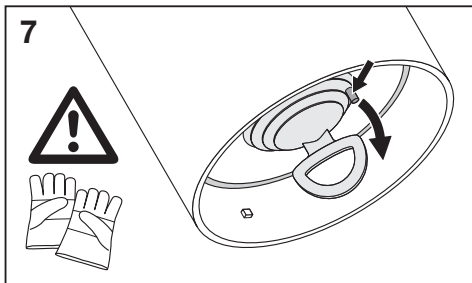
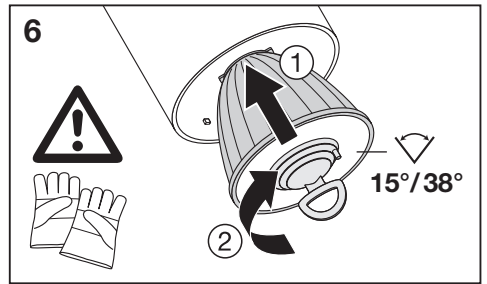
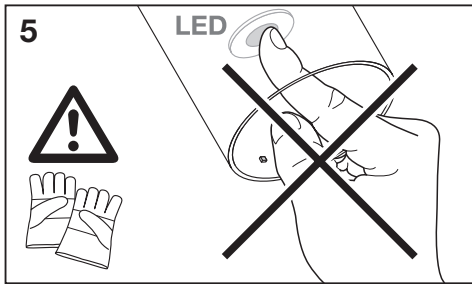
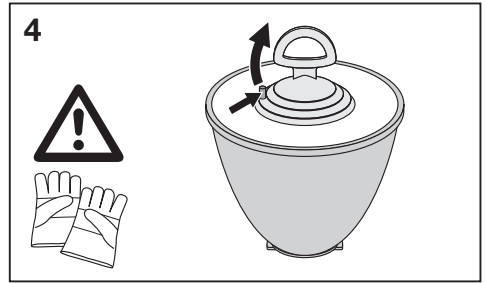
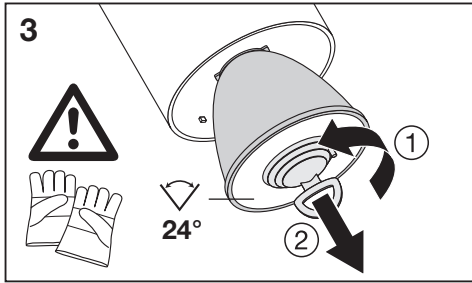
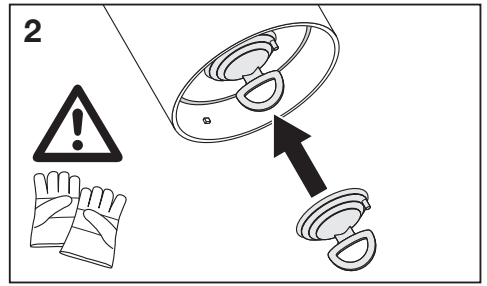
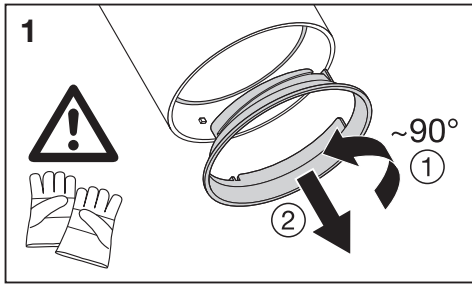

LEDVANCE GmbH
Steinerne Furt 62
86167 Augsburg, Germany
www.ledvance.com

C10449057
G11159164
13.12.22

© LEDVANCE Ltd, Aquila House
Delta Crescent, Westbrook, Warrington
WA5 7NR, United Kingdom